



SSCP005GSB

High Frequency High Gain PNP Power BJT

➤ Features

VCE	VBE	VCESAT Typ.	IC
-40V	-6V	-150mV	-3A

➤ Description

This device is produced with advanced high carrier density technology, which is especially used to minimize saturation voltage drop. This device particularly suits low voltage applications such as portable equipment, power management and other battery powered circuits, and low in-line power dissipation are needed in a very small outline surface mount package. Excellent thermal and electrical capabilities.

➤ Applications

- Battery powered circuits
- Low in-line power dissipation circuits
- Power regulator

➤ Pin configuration

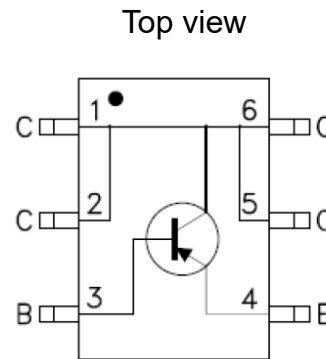

SOT23-6L

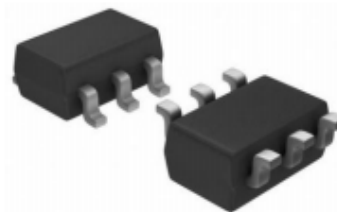

Bottom view

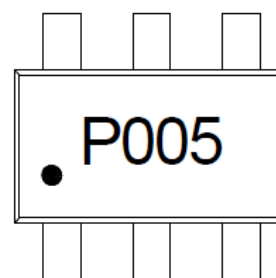

Marking

➤ Ordering Information

Device	Package	Shipping
SSCP005GSB	SOT23-6L	3000/Reel



➤ **Absolute Maximum Ratings**($T_A=25^{\circ}\text{C}$ unless otherwise specified)

Symbol	Parameter	Ratings	Unit
V_{CBO}	Collector-Base Voltage	-40	V
V_{CEO}	Collector-Emitter Voltage	-40	V
V_{EBO}	Emitter-Base Voltage	-6	V
I_C	Collector Current@Note1	-3	A
	Collector Current@Note2	-2	
I_{CM}	Pulsed Collector Current@Note3	-6	A
P_D	Power Dissipation@Note1	1.2	W
	Power Dissipation@Note2	0.8	
T_A	Operation Temperature Range	-40 to 85	$^{\circ}\text{C}$
T_L	Lead Temperature	260	$^{\circ}\text{C}$
T_J, T_{STG}	Operation and Storage temperature range	-55 to 150	$^{\circ}\text{C}$

➤ **Thermal Resistance Ratings**

Symbol	Parameter	Maximum	Unit
$R_{\theta JA}$	Junction-to-Ambient Thermal Resistance@Note1	109	$^{\circ}\text{C}/\text{W}$
$R_{\theta JA}$	Junction-to-Ambient Thermal Resistance@Note2	160	

**➤ Electronics Characteristics**($T_A=25^{\circ}\text{C}$ unless otherwise specified)

Symbol	Parameter	Test Conditions	Min	Typ.	Max	Unit
BVCBO	Collector-Base Breakdown Voltage	$I_C=-50\mu\text{A}$ $I_E=0$	-40			V
BVCEO	Collector-Emitter Breakdown Voltage	$I_C=-1\text{mA}$ $I_B=0$	-40			V
BVEBO	Emitter-Base Breakdown Voltage	$I_E=-1\mu\text{A}$ $I_C=0$	-6			V
ICBO	Collector cut off current	$V_{CB}=-20\text{V}$ $I_E=0$			-0.1	μA
IEBO	Emitter cut off current	$V_{EB}=-4\text{V}$ $I_C=0$			-0.1	μA
HFE	DC Current Gain@Note3	$V_{CE}=-2\text{V}$ $I_C=-0.5\text{A}$	100	200	350	
VCESAT	Collector-Emitter Saturation Voltage	$I_C=-1.5\text{A}$ $I_B=-80\text{mA}$			-0.2	V
VBESAT	Base-Emitter Saturation Voltage	$I_C=-1.5\text{A}$ $I_B=-80\text{mA}$			-1.2	V
f_T	Transition frequency	$V_{CE}=-5\text{V}$, $I_E=-0.1\text{A}$ $f=10\text{MHz}$	50	80		MHz

Notes:

1. Surface mounted on FR-4 Board using 1 square inch pad size, 1oz copper.
2. Surface mounted on FR-4 Board using minimum pad size, 1oz copper.
3. Pulse width=300us, Duty Cycle<2%.

➤ Typical Performance Characteristics

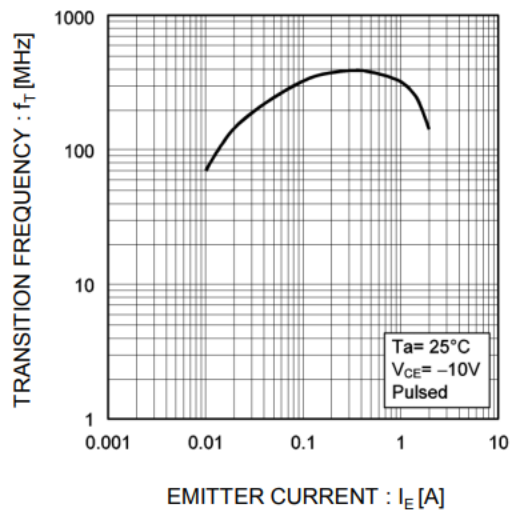
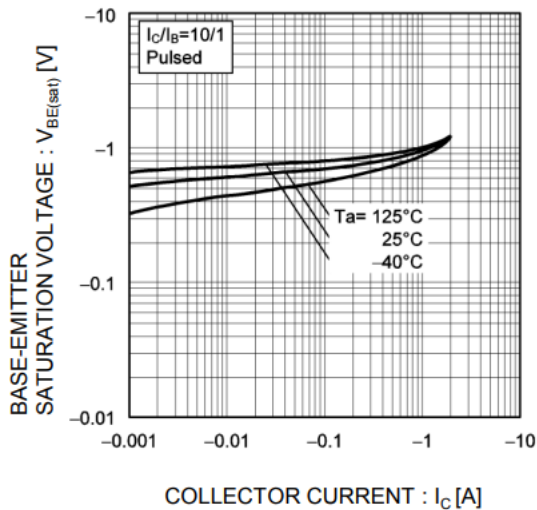
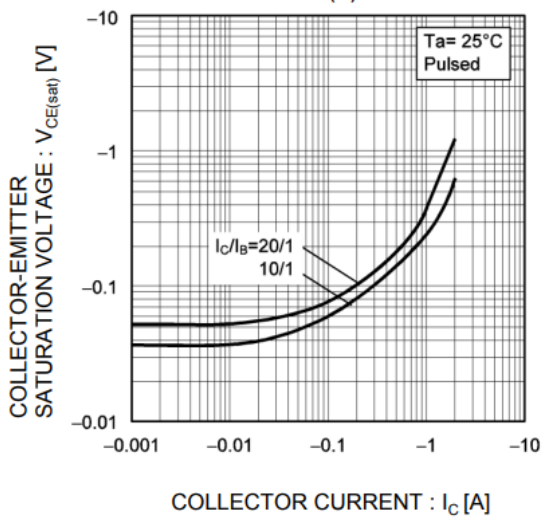
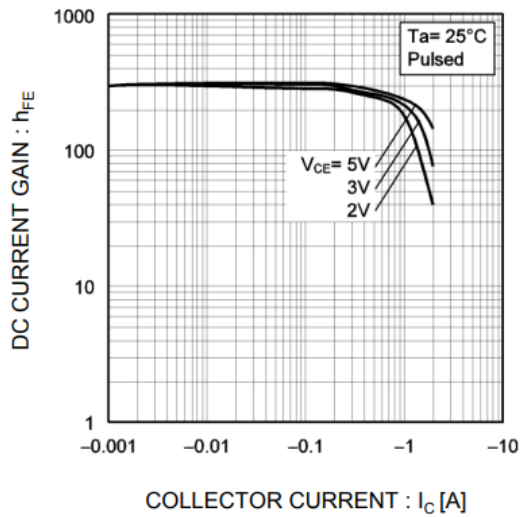
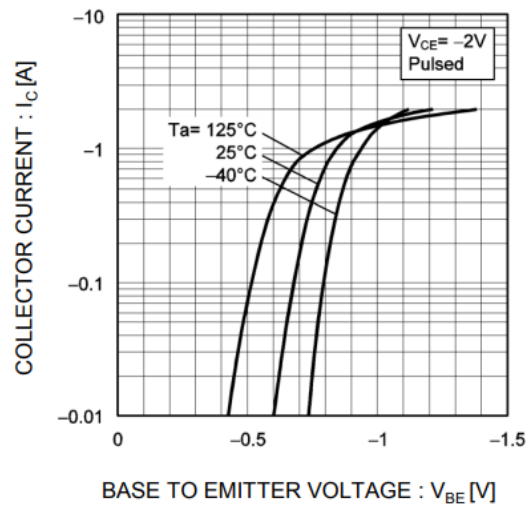
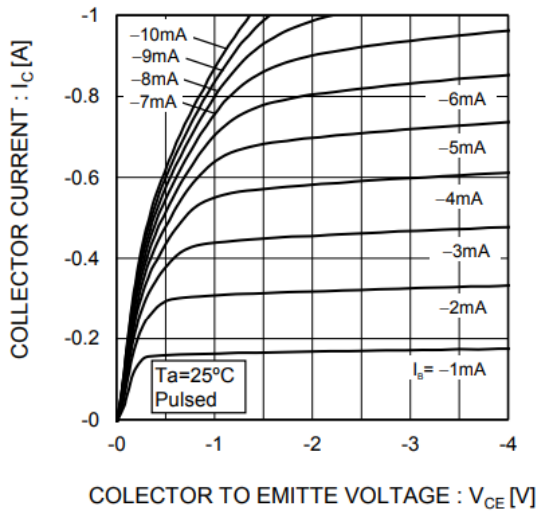



➤ Package Information

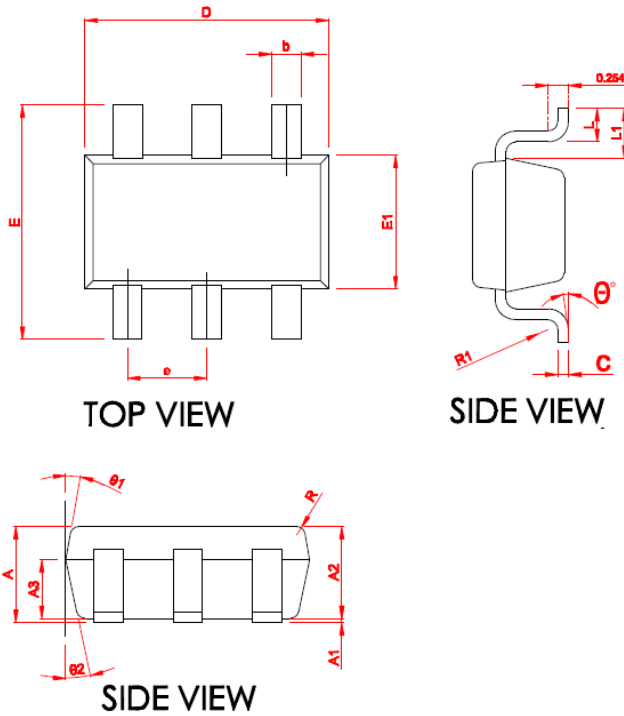

SYMBOL	MILLIMETER		
	MIN	NOM	MAX
A	1.06	1.15	1.24
* A1	0.01	0.05	0.09
* A2	1.05	1.10	1.15
A3	0.65	0.70	0.75
* b	0.30	0.35	0.45
* c	0.117	0.127	0.157
* D	2.87	2.92	2.97
* E	2.72	2.80	2.88
* E1	1.55	1.60	1.65
* e	0.90	0.95	1.00
* L	0.32	0.40	0.48
* L1	0.55	0.60	0.65
R	0.10 REF		
R1	0.12 REF		
* θ	0	--	8°
θ_1	8°	10°	12°
θ_2	10°	12°	14°

DISCLAIMER

AFSEMI RESERVES THE RIGHT TO MAKE CHANGES WITHOUT FURTHER NOTICE TO ANY PRODUCTS HEREIN TO IMPROVE RELIABILITY, FUNCTION OR DESIGN. AFSEMI DOES NOT ASSUME ANY LIABILITY ARISING OUT OF THE APPLICATION OR USE OF ANY PRODUCT OR CIRCUIT DESCRIBED HEREIN; NEITHER DOES IT CONVEY ANY LICIENCE UNDER ITS PATENT RIGHTS, NOR THE RIGHTS OF OTHERS.

THE GRAPHS PROVIDED IN THIS DOCUMENT ARE STATISTICAL SUMMARIES BASED ON A LIMITED NUMBER OF SAMPLES AND ARE PROVIDED FOR INFORMATIONAL PURPOSE ONLY. THE PERFORMANCE CHARACTERISTICS LISTED IN THEM ARE NOT TESTED OR GUARANTEED. IN SOME GRAPHS, THE DATA PRESENTED MAY BE OUTSIDE THE SPECIFIED OPERATING RANGE (E.G. OUTSIDE SPECIFIED POWER SUPPLY RANGE) AND THEREFORE OUTSIDE THE WARRANTED RANGE.